

WeldFil

Art. No.: 34 270

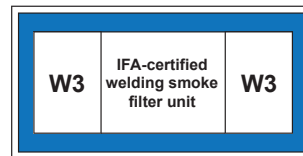
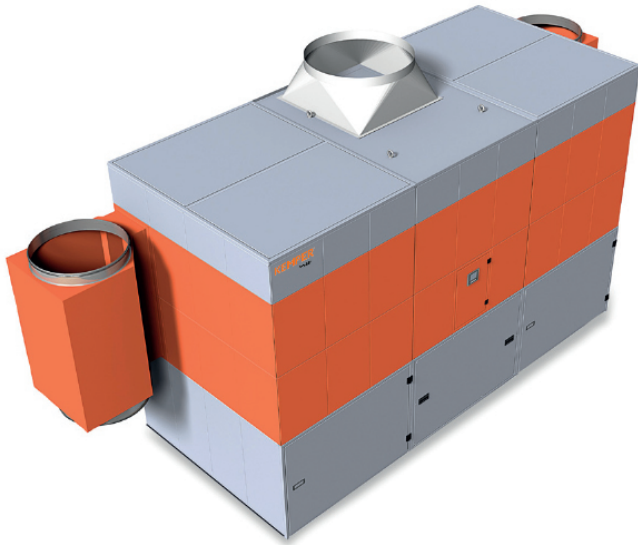

Applications

- High levels of smoke and dust
- Training centres and robotic welding lines
- Laser, plasma and flame cutting systems
- Can be installed outdoors
- Welding and grinding shops

Benefits

- Contamination-free dust collection due to compressed air fixation of dust collection containers
- Uninterrupted continuous operation due to automatic differential pressure-controlled filter cleaning
- Little noise emission due to a low noise level
- Expandable due to simple modular construction
- Considerable energy cost savings by using the automatic extraction volume control
- Convenient operation due to intelligent control via touch screen with diagnostic system
- Flexible integration of the control system into third-party systems such as cutting equipment due to potential-free contacts
- Best health protection for employees by use of KemTex® ePTFE cartridges with surface filtration

Properties

- Automatic filter cleaning, pressure-controlled
- Control via touch screen
- KemTex® ePTFE filter cartridges
- Dust collection container with pneumatic lifting device
- Modular design
- Automatic extraction volume control (optional)

Accessories

- Automatic dust disposal - DustEvac
- Automatic extraction volume control
- External On/Off
- Fleet management, remote maintenance and pre-noise maintenance using autarkic networking via mobile radio to the KEMPER cloud
- Spark separator – SparkTrap
- Weatherproof housing for outdoor installation

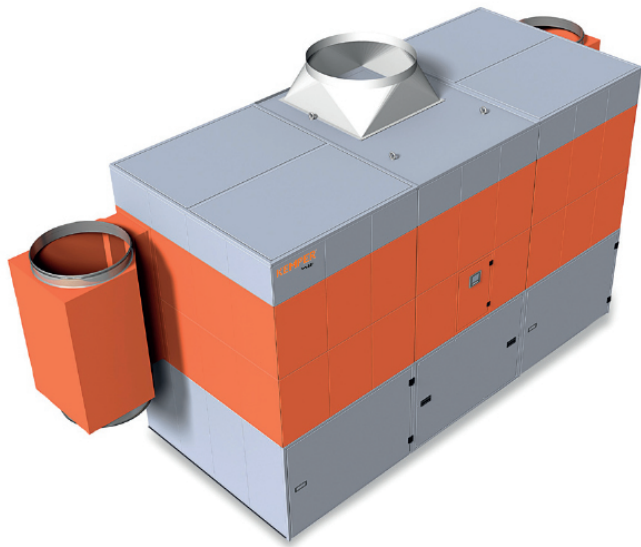

Technical Data

Filter

Filter stages	1
Filter method	Cleanable filter
Filter cleaning method	Rotating nozzle
Filter surface	20 m ²
Number filter elements	18
Filter surface total	360 m ²
Type of filter	Filter cartridge
Filter material	ePTFE membrane
Filter efficiency	> 99.99 %
Dust classification	M

Basic data

Extraction capacity	18500 - 26640 m ³ /h
Vacuum	2250 - 1800 Pa
Weight	2420 kg
Motor power	22 kW
Power supply	3 x 400 V / 50 Hz
Rated current	40 A
Noise level	65 dB(A)

Additional information

Fan type	Radial fan, belt driven
Compressed air supply	5 - 6 bar
Air outlet	900 mm
Air intake	2 x 710 mm
Capacity Dust collection container	2 x 192 l

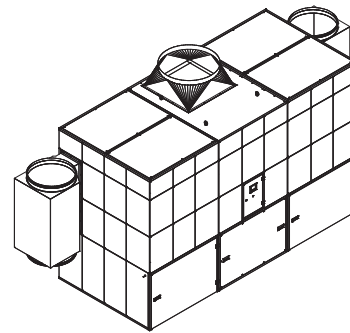
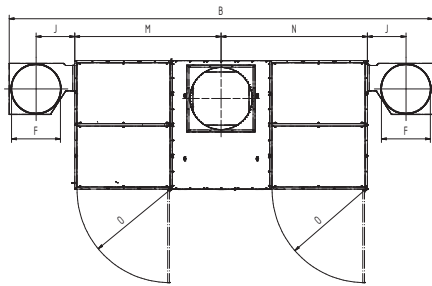
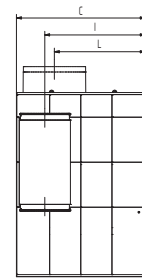
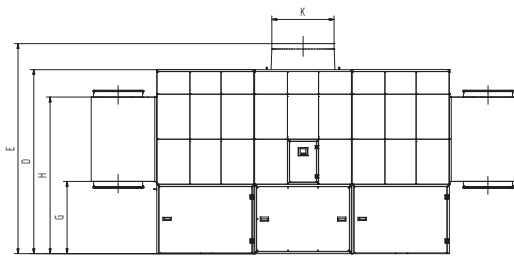

Technical Data

Dimensions

B	6139 mm
C	1864 mm
D	2670 mm
E	3070 mm
F	710 mm
G	1047 mm
H	2271 mm
I	1453 mm
J	560 mm
K	900 mm
L	1314 mm
M	2119.5 mm
N	2119.5 mm
O	1347 mm

The shown transition pieces are optional

Pressure-volume graph

- Fan characteristic curve
- Working pressure increase
- ▨ Recommended Use

